

# FRAMELESS SLIDING SHOWER DOOR SYSTEMS



*Serenity Series*



**glass  
magazine  
award  
winner**

See Pages FS04 and FS05 for  
Details on our Glass Magazine  
Award Winning Serenity Series  
Sliding Door System

**"Most  
Innovative  
Bath Enclosure  
Product"**

**RESIDENTIAL UPGRADES**  
BRINGING HIGH SCALE QUALITY TO DESIGNER BATHROOMS

**COMMERCIAL PROJECTS**  
THE CHOICE BY MANY OF THE FINEST HOTELS, RESORTS,  
AND CONDOMINIUM COMPLEXES AROUND THE WORLD



*Hydroslide Series*



*Cottage Series*



**C.R. LAURENCE COMPANY**

Worldwide Manufacturer and Supplier

Glazing, Architectural, Railing, Construction, Industrial, and Automotive Supplies

[crlaurence.com](http://crlaurence.com)

[crl-arch.com](http://crl-arch.com)

[usalum.com](http://usalum.com)

# ESSENCE SERIES HEADERLESS ROLLING SHOWER DOOR SYSTEM

## ESSENCE SERIES HEADERLESS ROLLING SHOWER DOOR SYSTEM

**NEW!**

- Headerless System Offers Popular Frameless Look
- Bottom Rolling System Has Integrated Height Adjustment
- Rollers Include Anti-Derail/Anti-Pinch Guard
- Choice of Rounded or Square Style Roller System
- For Use Only With 1/2" (12 mm) Thick Tempered Glass (Not Included)

AVAILABLE IN FOUR STOCK FINISHES



Our **NEW** Essence Series allows a headerless appearance by utilizing a bottom rolling system that includes an anti-derail/anti-pinch guard feature. The bottom rollers also have an integrated height adjustment for door to vertical jamb alignment. By being completely header-free, a frameless vertical and horizontal appearance is achieved. Smooth and quiet operation of the door is the cornerstone of this bottom rolling unit. At the same time, excellent water management is accomplished at the sill via the bottom track, and vertically with the use of a clear L-shape jamb having a soft seal/bumper.

With your separate addition of a free standing shower head and valves, new configurations are possible, such as beautiful island designs, U-shaped designs, and L-shaped designs with unconventionally placed plumbing walls.

The Essence Series Frameless Sliding Shower Door System is for use only with 1/2" (12 mm) thick tempered safety glass (not included). It is stocked in four popular finishes, with a choice of rounded or square corner rollers.

Sold in a Basic Kit that allows both 180 degree and 90 degree installations, the user simply orders the necessary Brackets, and Handle or Knob separately to complete the installation. See the important **HOW TO ORDER** section at the bottom right of this page.

### SPECIFICATIONS:

**Glass Thickness Range:** 1/2" (12 mm) Tempered Safety Glass (Not Included)

**Material:** Rollers and Top Guide Constructed of Solid Brass; Bottom Sliding Track and U-Channel Constructed of Aluminum; Clear Plastic L-Jamb

**Maximum Door Size:** Do Not Exceed Either 34" (864 mm) Wide or 127 Pounds (57.6 kg)

**Basic Kit Fabrication:** Notch Required for Bottom Rollers, Holes Required for Top Guide (see [crlaurence.com](http://crlaurence.com) for details)



Rounded Roller Style



Square Corner Roller Style



Plumbing Fixture Not Included

### BASIC ESS1 OR ESS3 KITS INCLUDE THE FOLLOWING:

- Two - Bottom Rollers
- One - Spanner Wrench for Roller Adjustment
- One - Top Door Guide
- One - 64" (1.63 m) Bottom Track
- One - 98" (2.49 m) U-Channel
- One - 98" (2.49 m) Plastic L-Seal
- One - SDCEC12 End Cap for Channel
- One - M6164 Shower Door Bumper
- One - 1" (25.4 mm) Long Drain Piece for Track
- One - 1/16" (1.6 mm) Neoprene Setting Block

**NOTE:** Glass Brackets, Handle or Knob, and Other Accessories Sold Separately

### HOW TO ORDER FOR 180 DEGREE WALL-TO-WALL INSTALLATION

1. Order Basic ESS1 or ESS3 Kit in Your Choice of Finish
2. Order Two Each CL90S (Rounded) or GE90S (Square Cornered) Wall Mount Brackets, plus
3. Order Your Choice of Handle or Knob for Door
4. Order Any Other Accessories You May Want for the Enclosure

### HOW TO ORDER FOR 90 DEGREE RETURN PANEL INSTALLATION

1. Order Basic ESS1 or ESS3 Kit in Your Choice of Finish
2. Order Two Each CL90S (Rounded) or GE90S (Square Cornered) Wall Mount Brackets, plus Two Each CLO90 (Rounded) or GE090 (Square Cornered) 90 Degree Glass-to-Glass Brackets
3. Order Your Choice of Handle or Knob for Door
4. Order Any Other Accessories You May Want for the Enclosure

POLISHED CHROME CAT. NO.	BRUSHED NICKEL CAT. NO.	POLISHED BRASS CAT. NO.	OIL RUBBED BRONZE CAT. NO.	DESCRIPTION
ESS1CH	ESS1BN	ESS1BR	ESS1ORB	Basic Rounded Roller Style Essence Kit
ESS3CH	ESS3BN	ESS3BR	ESS3ORB	Basic Square Cornered Roller Style Essence Kit
BR4CH	BR4BN	BR4BR	BR4ORB	Replacement Rounded Style Bottom Roller
SR4CH	SR4BN	SR4BR	SR4ORB	Replacement Square Cornered Bottom Roller
TG4CH	TG4BN	TG4BR	TG4ORB	Replacement Top Guide
BT4CH	BT4BN	BT4BR	BT4ORB	64" (1.63 m) Replacement Bottom Track
SDCD12BA	SDCD12BN	SDCD12BGA	SDCD12ORB	98" (2.49 m) Replacement U-Channel
DK98L	DK98L	DK98L	DK98L	98" (2.49 m) Replacement Clear Plastic L-Seal

**NOTE:** Glass Brackets, Door Handle or Knob, and Other Items Sold Separately

# ESSENCE SERIES ROLLING SHOWER DOOR SYSTEM (WITH HEADER)

## ESSENCE SERIES ROLLING SHOWER DOOR SYSTEM (WITH HEADER)

- Header System Allows for Use of 3/8" or 1/2" (10 or 12 mm) Thick Tempered Glass (Not Included)
- Header is Supported by Fixed Panel Glass With Attractive Thru-Glass Fittings
- Bottom Rolling System Has Integrated Height Adjustment
- Rollers Include Anti-Derail/Anti-Pinch Guard
- Choice of Rounded or Square Cornered Roller System

Our **NEW** Essence Series Sliding Door System With Header adds to CRL's growing line of modern systems. The Header is supported by the fixed panel glass with the use of attractive thru-glass fittings. The bottom rolling system has an integrated height adjustment for door to vertical jamb alignment. The Bottom Rollers also include an anti-derail/anti-pinch guard feature. Smooth and quiet door operation is the cornerstone of the Essence Series. At the same time, water management is accomplished at the sill via the bottom track, and vertically with the use of a clear L-shape jamb that has a soft seal/bumper.

The Essence Sliding Door System With Header is sold in a Basic Kit that allows 180 degree installations. For 90 degree installations a 90RF Return Fitting must be ordered as well. A choice of rounded or square cornered design rollers allows aesthetic matching to the bathroom surroundings.

This System may be used with 3/8" or 1/2" (10 or 12 mm) thick tempered safety glass. It is stocked in four popular finishes in a choice of 60" or 84" (1.52 or 2.13 m) length Kits. See the important **HOW TO ORDER** section at the bottom right of this page.

### SPECIFICATIONS:

**Glass Thickness Range:** 3/8" or 1/2" (10 or 12 mm) Thick Tempered Safety Glass (Not Included)

**Material:** Header Constructed of Aluminum; Bottom Rollers and Top Guide Constructed of Solid Brass; Bottom Sliding Track and U-Channel Constructed of Aluminum; Clear Plastic L-Jamb

**Maximum Door Size:** For 3/8" (10 mm) Glass: Do Not Exceed Either 34" (864 mm) Wide or 109 Pounds (49 kg); For 1/2" (12 mm) Glass: Do Not Exceed Either 34" (864 mm) Wide or 127 Pounds (58 kg);

**Basic Kit Fabrication:** Notch Required for Bottom Rollers, Holes Required for Top Guide; Holes Required for 180° and 90° Thru Glass Fittings. (see [crlaurence.com](http://crlaurence.com) for details)

POLISHED CHROME CAT. NO.	BRUSHED NICKEL CAT. NO.	POLISHED BRASS CAT. NO.	OIL RUBBED BRONZE CAT. NO.	DESCRIPTION
ESS560CH	ESS560BN	ESS560BR	ESS560ORB	60" (1.52 m) Basic 180° Rounded Style Essence Kit With Header
ESS584CH	ESS584BN	ESS584BR	ESS584ORB	84" (2.13 m) Basic 180° Rounded Style Essence Kit With Header
ESS760CH	ESS760BN	ESS760BR	ESS760ORB	60" (1.52 m) Basic 180° Square Style Essence Kit With Header
ESS784CH	ESS784BN	ESS784BR	ESS784ORB	84" (2.13 m) Basic 180° Square Style Essence Kit With Header
BR4CH	BR4BN	BR4BR	BR4ORB	Replacement Rounded Style Bottom Roller
SR4CH	SR4BN	SR4BR	SR4ORB	Replacement Square Style Bottom Roller
HTG4BN	HTG4BN	HTG4BN	HTG4BN	Top Guide Roller (Brushed Nickel Only - Not Exposed)
FGF4CH	FGF4BN	FGF4BR	FGF4ORB	Replacement 180 Degree Fixed Glass Fiting
90RFCH	90RFBN	90RFBR	90RFORB	90 Degree Return Fitting
ESSH60CH	ESSH60BN	ESSH60BR	ESSH60ORB	60" (1.52 m) Replacement Header/Header Cover
ESSH84CH	ESSH84BN	ESSH84BR	ESSH84ORB	84" (2.13 m) Replacement Header/Header Cover
BT484CH	BT484BN	BT484BR	BT484ORB	84" (2.13 m) Replacement Bottom Track
SDCD38BA	SDCD38BN	SDCD38BGA	SDCD38ORB	98" (2.49 m) Replacement U-Channel for 3/8" (10 mm)
SDCD12BA	SDCD12BN	SDCD12BGA	SDCD12ORB	98" (2.49 m) Replacement U-Channel for 1/2" (12 mm)
DK98L	DK98L	DK98L	DK98L	98" (2.49 m) Replacement Clear Plastic L-Seal

**NOTE:** Door Handle or Knob and Other Items Sold Separately

**NEW!**

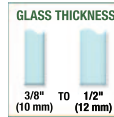

Plumbing Fixture Not Included



Rounded Roller Style



Square Corner Roller Style

AVAILABLE IN FOUR STOCK FINISHES

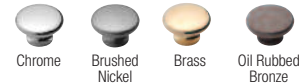

### BASIC 180 DEGREE KIT INCLUDES THE FOLLOWING:

- One - 60" (1.52 m) or 84" (2.13 m) Header
  - One - Pack of Two BWB2 Header Mounting Brackets
  - Two - Bottom Rollers
  - One - Spanner Wrench for Roller Adjustment
  - One - Top Guide/Roller
  - One - 60" (1.52 m) or 84" (2.13 m) Bottom Track
  - One - 98" (2.49 m) U-Channel
  - One - 98" (2.49 m) Plastic L-Seal
  - Two - 180 Degree Fixed Glass Fittings
  - One - SDCEC12 or SDCEC38 End Cap for Channel
  - One - M6164 Shower Door Bumper
  - One - 1" (25.4 mm) Long Drain Piece for Track
  - One - 1/16" (1.6 mm) Neoprene Setting Block
- NOTE:** Handle or Knob and Other Accessories Sold Separately

### HOW TO ORDER FOR 180 DEGREE WALL-TO-WALL INSTALLATION

1. Order Basic 180 Degree Kit in Your Choice of Finish
2. Order Your Choice of Handle or Knob for Door
3. Order Any Other Accessories You May Want for the Enclosure

### HOW TO ORDER FOR 90 DEGREE RETURN PANEL INSTALLATION

1. Order Basic 180 Degree Kit in Your Choice of Finish
2. Order 90RF 90 Degree Return Fitting in Choice of Finish
3. Order Your Choice of Handle or Knob for Door
4. Order Any Other Accessories You May Want for the Enclosure

# DELUXE SERENITY SERIES 180 DEGREE AND 90 DEGREE SHOWER DOOR SYSTEMS

## DELUXE SERENITY SERIES SLIDING SHOWER DOOR SYSTEMS

- Unique 180 Degree System With Rollers Above and Below the Header Bar
- System Features One Sliding Door and One Fixed Panel
- Fixed and Sliding Glass Panels are Reversible for Installation
- Use of Minimal Hardware Gives Door an Almost Floating Appearance
- For 5/16" to 3/8" (8 to 10 mm) Thick Tempered Glass (Not Included)
- Specially Designed Roller Bearings Allow Quiet Door Movement
- Accessory Kit Available for 90 Degree Return Panels
- Choice of Durable Polished or Brushed Stainless Steel Finishes



5/16" to 3/8"

Our Deluxe Serenity Series Sliding Door System has an entirely different look from traditional sliding shower door systems. The use of minimal hardware provides a frameless look that gives the enclosure an almost floating appearance. Specially designed roller bearings allow for quiet, easy opening and closing of the door. This unique roller system operates above and below the header bar that spans the top of the enclosure. One sliding and one fixed panel make the 180 Degree Standard Kit beautiful and practical. The Kit includes all items pictured at bottom right of the page, with the exception of the 90 Degree Accessory Kit, which is purchased separately (see bottom left of page). The durable polished or brushed stainless steel units will work with 5/16" or 3/8" (8 or 10 mm) thick tempered glass (not included).



### SPECIFICATIONS:

**Glass Thickness Range:** 5/16" or 3/8" (8 or 10 mm)  
Tempered Safety Glass (Not Included)

**Material:** Stainless Steel

**Maximum Door Size:** Do Not Exceed Either 30" (762 mm) Wide or 88 Pounds (40 kg)

**Fabrication:** Holes Required in Both Door and Fixed Panel  
(see [crlaurence.com/shower-sliders](http://crlaurence.com/shower-sliders) for details)

**PHOTO GALLERY**  
[crlaurence.com](http://crlaurence.com)

AVAILABLE IN TWO STOCK FINISHES

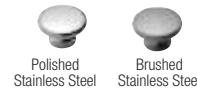

glass  
magazine  
award  
winner

BRUSHED STAINLESS CAT. NO.	POLISHED STAINLESS CAT. NO.	DESCRIPTION
SER78BS	SER78PS	Standard 180 Degree Kit
SER90BS	SER90PS	90 Degree Accessory Kit
SERH2BS	SERH2PS	78-3/4" (2 m) Replacement Header Bar Only
SERNR1BS	SERNR1PS	Replacement Roller (1/Pack)
SERNS1BS	SERNS1PS	Replacement Stopper (1/Pack)
SERAHW2BS	SERAHW2PS	Track Holder Fittings for Wall (2/Pack)
SERFP2BS	SERFP2PS	Track Holder Fittings for Fixed Panel (2/Pack)
SERNG2BS	SERNG2PS	Replacement Door Guide (1/Pack)
SERNHP2BS	SERNHP2PS	Thru-Glass Pull
DK98L	DK98L	98" (2.49 m) Replacement Clear Plastic L-Seal

**CAT. NO. SER90**  
Accessory Kit for 90 Degree Return is used in conjunction with Track Holder Fitting for Wall (sold separately, at right)

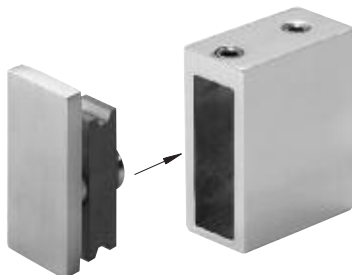

**CAT. NO. SERAHW2**  
Track Holder Fitting for Wall is used in conjunction with 90° Accessory Kit (sold separately, at left)

### STANDARD 180 DEGREE KIT INCLUDES:

- One - 78-3/4" (2 m) Length Header Bar
- Four - Rollers
- One - Stopper
- Two - Track Holder Fittings for Wall
- Two - Track Holder Fittings for Fixed Panel
- One - Thru-Glass Pull
- One - Door Guide
- One - 85" (2.16 m) Clear L-Jamb



Rollers



Stoppers



Thru-Glass Pull



Track Holder Fittings for Wall



Track Holder Fittings for Fixed Panel



L-Seal Clear Jamb



Door Guide

# DELUXE SERENITY SERIES DOUBLE DOOR CORNER SYSTEM

## DELUXE SERENITY SERIES DOUBLE DOOR CORNER SYSTEM

- Create an Attractive 90 Degree Double Door Corner System
- Simply Combine Two Deluxe Serenity 180 Degree Kits and One 90 Degree Double Door Connector Bracket (Shown Below)
- V-Corner Double Door Design is Ideal for Smaller Bathrooms
- Choice of Durable Polished or Brushed Stainless Steel Finishes



5/16" to 3/8"

Creating a unique and attractive Double Door shower enclosure is now easier than ever. Simply join two 180 Degree Serenity Series Sliding Systems (see opposite page), along with one 90 Degree Double Door Connector Bracket (see right). Combining the two sliding doors in a V-corner allows you to build a beautiful double door sliding enclosure ideal for smaller bathroom areas. A choice of beautiful and durable polished or brushed stainless steel finishes help to match most any modern bathroom décor. No glass fabrication is required for the Connector Bracket itself. Minimum order is one each.

AVAILABLE IN TWO STOCK FINISHES

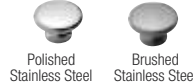

**Note:** Each Sliding Door Cannot Exceed 17" (432 mm) in Width or 51 Pounds (23 kg)

**MORE INFORMATION**  
[crlaurence.com](http://crlaurence.com)



Front View



Rear View

90 Degree Door Connector Bracket

**CAT. NO. SERC2PS** = Polished Stainless

**CAT. NO. SERC2BS** = Brushed Stainless



# HYDROSLIDE SERIES

## 180 DEGREE AND 90 DEGREE SHOWER DOOR SYSTEMS

# HYDROSLIDE

## 180° and 90° SLIDING SHOWER DOOR SYSTEMS

- Excellent Design for Compact Areas
- Clean, Sleek Lines
- Accommodates a Wide Range of Shower Designs
- Quick and Easy Installation

AVAILABLE IN FOUR STOCK FINISHES

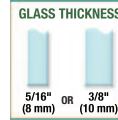

Hydroslide Sliding Shower Door Kits were designed for full standing showers or above bathtubs. The Hydroslide System can accommodate a wide range of shower designs with fixed glass panels on either end, or both sides at 90 or 180 degrees. The Hydroslide System also accommodates the option of floor-to-near-ceiling glass panels with a sliding door. Hydroslide Sliding Shower Door Kits feature the latest European 'all-glass' look. Kits are available in either 60" (1.52 m) or 84" (2.13 m) widths. Installers can cut the width to size, and height is optional as long as the sliding door glass weighs less than 88 pounds (40 kg).

The 180 Degree Wall-to-Wall Installation only requires the 180 Degree Standard Kit for the installation. The 90 Degree Wall-to-Glass Installation requires the 180 Degree Standard Kit, plus the 90 Degree Wall-to-Glass Accessory Kit. Individual or replacement parts can also be ordered from the next page. Hydroslide Kits come in four finishes: Chrome Fittings with a Brite Anodized Sliding Track, Polished Brass with a Brite Gold Anodized Sliding Track, Brushed Nickel with Brushed Nickel Anodized Sliding Track, and Oil Rubbed Bronze with Oil Rubbed Bronze Anodized Sliding Track. Each Kit comes with complete fabrication and installation instructions.

**NOTE:** Bottom Fixed Glass Attachments, Handles or Knobs must be ordered separately.

### 180 DEGREE STANDARD KITS CONSIST OF:

- One - Sliding Glass Door Upper Track
- Two - Hangers for Sliding Glass Door
- Two - Sliding Glass Door Rollers
- Two - Sliding Glass Door Roller Stops
- One - Sliding Glass Door Floor Guide
- Two - 90 Degree Wall-to-Upper Track Connectors
- Two - 180 Degree Glass-to-Sliding Track Connectors
- One - 36" (.91 m) Half-Round SDT980 Threshold
- One - 98" (2.49 m) DK98L L-Seal for Wall

### \*90 DEGREE WALL-TO-GLASS ACCESSORY KITS CONSIST OF:

- One - 90 Degree Glass-to-Sliding Track Connector
- One - 90 Degree Wall-to-Glass Bracket

\*90 Degree Units require that you order one 180 Degree Standard Kit plus one 90 Degree Accessory Kit

180 DEGREE STANDARD KIT 60" (1.52 M) CAT. NO.	180 DEGREE STANDARD KIT 84" (2.13 M) CAT. NO.	90 DEGREE WALL-TO-GLASS ACCESSORY KIT CAT. NO.	FINISH
HYDK60CH	HYDK84CH	HYDA9CH	Brite Anodized/Chrome
HYDK60BR	HYDK84BR	HYDA9BR	Brite Gold Anodized/Brass
HYDK60BN	HYDK84BN	HYDA9BN	Brushed Nickel
HYDK60ORB	HYDK84ORB	HYDA9ORB	Oil Rubbed Bronze

### SPECIFICATIONS:

**Glass Thickness Range:** 5/16" (8 mm) to 3/8" (10 mm) Tempered Safety Glass (Not Included)

**Material:** Plated or Lacquered Solid Brass Fittings; Anodized Aluminum Sliding Door Track

**Maximum Door Size:** 88 lbs (40 kg)

**Fabrication:** Holes Required in Fixed Panel and Door

**Includes:** Gaskets, Screws, and Glass Fabrication Information.

Complete installation instructions along with glass and metal cutting formula available at [crlaurence.com](http://crlaurence.com).

**NOTE:** Ask our Shower Door Technical Sales Department about a special Installation using two Hydroslide Kits, along with our HYDH90 90 Degree Bracket to allow two doors to meet at a 90 Degree Corner.

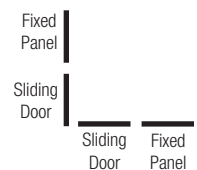

180 Degree Wall-to-Wall Installation  
Uses our 180 Degree Standard Kit



90 Degree Wall-to-Glass Installation  
Uses our 180 Degree Standard Kit  
plus a 90 degree Wall-to-Glass Accessory Kit

# HYDROSLIDE SERIES SLIDING SHOWER DOOR SYSTEM COMPONENTS

## HYDROSLIDE SYSTEM COMPONENTS

Hydroslide component parts can be ordered as replacement parts, or you can order the individual parts to fabricate your own custom installation

### SLIDING SHOWER DOOR UPPER TRACK

The extruded aluminum Sliding Shower Door Upper Track is available in two lengths and four finishes. You can easily cut to length for your installation. Longer lengths available on special order.

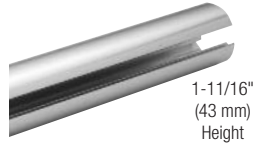

1-11/16"  
(43 mm)  
Height

BRITE ANODIZED CAT. NO.	BRITE GOLD ANODIZED CAT. NO.	BRUSHED NICKEL ANODIZED CAT. NO.	OIL RUBBED BRONZE CAT. NO.	LENGTH
HYD60BA	HYD60BGA	HYD60BN	HYD60ORB	60" (1.52 m)
HYD84BA	HYD84BGA	HYD84BN	HYD84ORB	84" (2.13 m)

### SLIDING DOOR HANGER KIT

Kit consists of two Rollers, two Glass Hangers, and two Snap-In Screw Covers.



CAT. NO.	FINISH
HYD01CH	Polished Chrome
HYD01BR	Polished Brass
HYD01BN	Brushed Nickel
HYD01ORB	Oil Rubbed Bronze

### 180 DEGREE GLASS-TO-SLIDING TRACK CONNECTOR

For attaching the fixed glass to the Sliding Shower Door Upper Track in 180 degree installations.



CAT. NO.	FINISH
HYDG180CH	Polished Chrome
HYDG180BR	Polished Brass
HYDG180BN	Brushed Nickel
HYDG180ORB	Oil Rubbed Bronze

### 90 DEGREE GLASS-TO-SLIDING TRACK CONNECTOR

For attaching the fixed glass to the Sliding Shower Door Upper Track in 90 degree installations.



CAT. NO.	FINISH
HYDG90CH	Polished Chrome
HYDG90BR	Polished Brass
HYDG90BN	Brushed Nickel
HYDG90ORB	Oil Rubbed Bronze

### SNAP-IN SCREW COVER KIT

Kit consists of two Snap-In Screw Covers.



CAT. NO.	FINISH
HYD04CH	Polished Chrome
HYD04BR	Polished Brass
HYD04BN	Brushed Nickel
HYD04ORB	Oil Rubbed Bronze

### SLIDING DOOR FLOOR GUIDE KIT

Kit consists of one Floor Guide and two Screws.

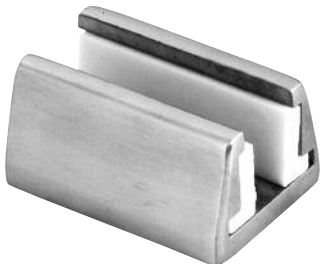

CAT. NO.	FINISH
HYD03CH	Polished Chrome
HYD03BR	Polished Brass
HYD03BN	Brushed Nickel
HYD03ORB	Oil Rubbed Bronze

### 90 DEGREE WALL-TO-GLASS BRACKET

For securing a glass panel at 90 degrees to the wall. Includes two Screws and Snap-In Screw Covers.



CAT. NO.	FINISH
HYD05CH	Polished Chrome
HYD05BR	Polished Brass
HYD05BN	Brushed Nickel
HYD05ORB	Oil Rubbed Bronze

**ROLLER STOP KIT** Kit consists of two Roller Stops and Screws.



CAT. NO.	COLOR
HYD02	Black

### 90 DEGREE WALL-TO-UPPER TRACK CONNECTOR

For attaching the Sliding Shower Door Upper Track to a wall at 90 degrees.



CAT. NO.	FINISH
HYDW90	Mill

### 90 DEGREE HYDROSLIDE HEADER BRACKET

To be used when two Hydroslide doors come together in a 90 degree corner. NOTE: Sliding panels not to exceed 17" (432 mm) in width.



CAT. NO. HYDH90

### WHITE BUSHING SPACER PACK

A White Bushing Spacer Pack is included in each Hydroslide Sliding Shower Door Kit, but this replacement pack is available if needed. Two each of three different sizes are used to help fill the holes drilled in glass and prevent slippage. Six per pack.

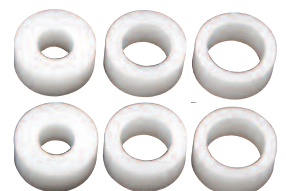

CAT. NO. HYDS

## HYDROSLIDE BI-FOLD HINGES

The Hydroslide Bi-Fold Hinges add a different element to the already popular Hydroslide System. Instead of a standard sliding door, you can now "Bi-Fold" two sliding panels of glass into the shower enclosure, creating a larger opening than the single sliding door will allow. Made of solid brass and available in four popular finishes, the Hydroslide Bi-Fold Hinges require holes in the glass. Used in conjunction with Hydroslide Header and a Hanger (both sold separately).



CAT. NO. HYDH037  
Wall Mount



CAT. NO. HYDH180  
180 Degree Glass-to-Glass

### SPECIFICATIONS:

**Glass Thickness Range:** 5/16" to 3/8" (8 to 10 mm) Tempered Safety Glass

**Construction:** Solid Brass

**Hinge Swings:** Bi-Fold into Shower Enclosure

**Closing Type:** Free Swinging

**Holes Required in Glass**

**Includes:** Gaskets, Screws, and Glass Fabrication Dimensions

**Available Finishes:** Polished Chrome, Polished Brass, Brushed Nickel, Oil Rubbed Bronze

**Maximum Capacities:** Do Not Exceed Either 48" (1.22 m) or 100 lbs. (45 kg) for Both Folding Doors Combined. Use Two Hinges Only on Each Sliding Panel.



SERENITY SERIES



SERENITY SERIES



COTTAGE SERIES



HYDROSLIDE SERIES



SERENITY SERIES



HYDROSLIDE SERIES



HYDROSLIDE SERIES



HYDROSLIDE SERIES

# COTTAGE CK SERIES FRAMELESS SLIDING SHOWER DOOR SYSTEM (CLEAR JAMBS)

## COTTAGE CK SERIES WITH CLEAR SIDE JAMBS

- Utilizes Clear Polycarbonate Side Jambs Instead of Traditional Metal Jambs
- Bolt-Through Top Hangers Provide for Immediate Fabrication and Installation
- Designed for Use With 3/8" (10 mm) or 1/4" (6 mm) Tempered Glass (Not Included)
- Brite Anodized, Brite Gold Anodized, Brushed Nickel, and Oil Rubbed Bronze in Up to Six Stock Sizes
- Custom Units Also Available

Cottage CK Series Bypass Sliders are unique in that they utilize clear polycarbonate side jambs instead of traditional metal side jambs, thus providing more of the popular 'all-glass' look. Bolt-Through Top Hangers allow immediate fabrication and installation, with no waiting for messy adhesive to dry. Cottage Series Kits come in Brite Anodized, Brite Gold Anodized, Brushed Nickel, and Oil Rubbed Bronze finishes, with other finishes available on special order.

The top hung stock units include: Header, Top Hangers for 1/4" (6 mm) or 3/8" (10 mm) glass, Clear Polycarbonate Side Jambs, Bottom Sill, Back-to-Back Knob, 24" (610 mm) Towel Bar, Nylon Rollers, and Bottom Guide. Tempered glass and silicone sealant are supplied by the installer to complete the installation. Since all rollers are overhead, the Bottom Sill and Clear Side Jambs are uncluttered, making cleaning easy. Available in up to six stock sizes. Extrusions, Bottom Guides, Hardware Packages, and other accessories may be ordered separately as well (see next page). Custom units are available.

### SPECIFICATIONS:

**Materials:** Extrusions (Aluminum); Side Jambs (Polycarbonate); Towel Bar (Brass Tubing); Knob (Solid Brass)

**For Glass Thickness:** 1/4" (6 mm) or 3/8" (10 mm) (Glass not included in Kit)

**Include:** Aluminum Extrusions, Top Hangers for 3/8" (10 mm) or 1/4" (6 mm), Clear Polycarbonate Jambs, 24" (610 mm) Towel Bar, Knob, Hardware Package, and Installation Instructions

**Glass Fabrication:** Towel Bar – Two 1/2" (12 mm) Diameter Holes, 24" (610 mm) Center-to-Center; Knob – One 1/2" (12 mm) Diameter Hole; Top Hangers – Four 1/2" (12 mm) Diameter Holes (two per glass panel) (see [crlaurence.com](http://crlaurence.com) for complete information).



Custom 90 Degree Unit Shown

The Clear Jamb System Changes How You View Frameless Sliding Shower Door Kits Because the Vertical Metal is Eliminated

### DESIGNED BY C.R. LAURENCE

1/4" (6 MM) GLASS* CAT. NO.	3/8" (10 MM) GLASS* CAT. NO.	SIZE (WIDTH X HEIGHT)
CK146060	CK386060	60" x 60" (1.52 m x 1.52 m)
CK146072	CK386072	60" x 72" (1.52 m x 1.83 m)
—	CK386080	60" x 80" (1.52 m x 2.03 m)
CK147260	CK387260	72" x 60" (1.83 m x 1.52 m)
—	CK387272	72" x 72" (1.83 m x 1.83 m)
—	CK387280	72" x 80" (1.83 m x 2.03 m)

\* Specify Finish When Ordering

#### AVAILABLE IN FOUR STOCK FINISHES

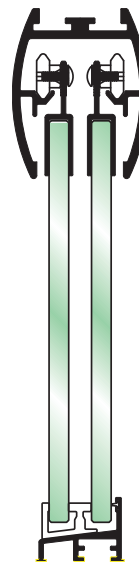
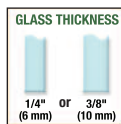

End View of Sliding Panels

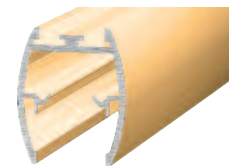

Header

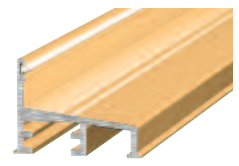

Bottom Sill



Top Hanger for 3/8" (10 mm) Glass



Top Hanger for 1/4" (6 mm) Glass



Clear Polycarbonate Jamb



Back-to-Back Knob (with Plastic Sleeve)



24" (610 mm) Towel Bar

# COTTAGE CK SERIES FRAMELESS SLIDING SHOWER DOOR SYSTEM COMPONENTS

## COTTAGE CK SERIES SYSTEM COMPONENTS

- Individual Supplementary Extrusions and Hardware Components to Convert Our Frameless Shower Door Kits Into Angled Enclosures or Wider Inline Units
- Brite Anodized, Brite Gold Anodized, Brushed Nickel, and Oil Rubbed Bronze Finishes to Match Our Kits
- Do It Yourself, or You Can Send Us a Drawing to Customize a Unit for You

CK Series Cottage Components were especially designed by CRL to add versatility to our Frameless Sliding Shower Door Kits. They allow the option of adding additional panels to create a designer enclosure, or simply construct your own sliding unit by combining the various parts. Stock lengths of Headers, Header Fillers, Bottom Sills, Sidelite Sills, and Clear Polycarbonate Vertical Side Jamb, along with Top Hangers and other accessory items round out the available items. Glass is not included.

Use these components to build the enclosure you desire, or even simpler, email or fax us a drawing (with dimensions) of the shower opening and we will put together a customized kit for you that will include everything you will need (except the glass and the silicone). Contact CRL Frameless Shower Technical Sales for details.

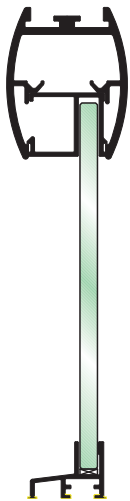
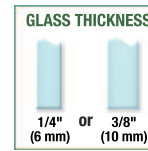

End View of Fixed Panel

### SPECIFICATIONS:

**Materials:** Extrusions (Aluminum), Side Jamb Seals (Polycarbonate), Knob (Solid Brass), Towel Bar (Brass Tubing)

**For Glass Thickness:** 1/4" (6 mm) or 3/8" (10 mm) (Glass not included)

### Recommended Maximum Slider Sizes:

1/4" (6 mm) Glass: 60" W x 72" H (1.52 x 1.83 m) or 72" W x 60" H (1.83 x 1.52 m); 3/8" (10 mm) Glass: 72" W x 80" H (1.83 x 2.03 m)

**Glass Fabrication:** See opposite page

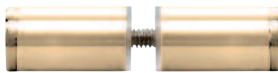

Back-to-Back Knob (with Plastic Sleeve)

**CAT. NO. SDKP112**



Towel Bar

**CAT. NO. BMNW24** = 24" (610 mm)

### Bottom Sill Filler Extrusion

**CAT. NO. DK7172**

Make your own bottom filler for out-of-level sills

Custom Made Tapered Bottom Sill Fillers

**CAT. NO. DK71**

Precision-made to order by C.R. Laurence Manufacturing

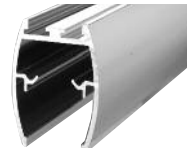

Header

**CAT. NO. DK61**

= 72" (1.83 m)

**CAT. NO. DK61144**

= 144" (3.66 m)

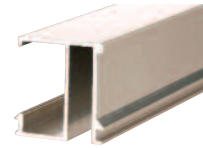

Header Filler

**CAT. NO. DK62**

= 72" (1.83 m)

**CAT. NO. DK62144**

= 144" (3.66 m)



Top Hanger

**CAT. NO. DK66**

for 3/8" (10 mm) Glass

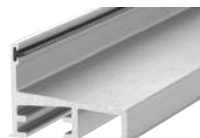

Bottom Sill

**CAT. NO. DK63**

= 72" (1.83 m)

**CAT. NO. DK63144**

= 144" (3.66 m)

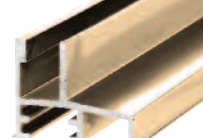

Sidelite Sill

**CAT. NO. DK64**

= 72" (1.83 m)

**CAT. NO. DK64144**

= 144" (3.66 m)



Top Hanger

**CAT. NO. DK67**

for 1/4" (6 mm) Glass



Bottom Guide

**CAT. NO. DK6914**

for 1/4" (6 mm) Glass

**CAT. NO. DK6938**

for 3/8" (10 mm) Glass

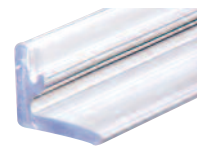

L-Shaped Clear Polycarbonate

**CAT. NO. DK98L**

= 98" (2.49 m)

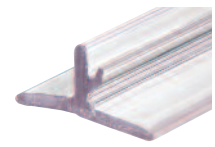

T-Shaped Clear Polycarbonate

**CAT. NO. DK98T**

= 98" (2.49 m)

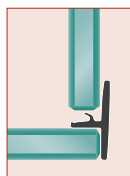
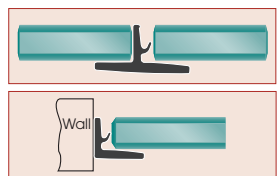

Polycarbonates adhere to glass or wall as shown using our Clear Very Hi-Bond Tape (not included).

### CATALOG NUMBERS FOR OTHER "CK" SERIES COMPONENTS

COMPONENT DESCRIPTION	BRITE ANODIZED	BRITE GOLD ANODIZED	BRUSHED NICKEL	OIL RUBBED BRONZE
Hardware Package	DK68B	DK68G	DK68B	DK68BL
Back-to-Back Knob	SDKP112CH	SDKP112BR	SDKP112BN	SDKP112ORB
24" Towel Bar	BMNW24CH	BMNW24BR	BMNW24BN	BMNW24ORB

# COTTAGE DK SERIES FRAMELESS SLIDING SHOWER DOOR SYSTEM (METAL JAMBS)

## COTTAGE DK SERIES WITH METAL SIDE JAMBS

- Utilizes Traditional Metal Side Jambs
- Bolt-Through Top Hangers Provide for Immediate Fabrication and Installation
- Designed for Use With 3/8" (10 mm) or 1/4" (6 mm) Tempered Glass (Not Included)
- Brite Anodized, Brite Gold Anodized, Brushed Nickel, and Oil Rubbed Bronze in Up to Six Stock Sizes
- Custom Units Also Available

Cottage DK Series Sliders utilize metal side jambs for a traditional frameless sliding shower door appearance. Bolt-Through Top Hangers allow immediate fabrication and installation, with no waiting for messy adhesive to dry. Our DK Series Kits come in Brite Anodized, Brite Gold Anodized, Brushed Nickel, and Oil Rubbed Bronze finishes, with other finishes available on special order.

The top hung stock units include: Extruded Aluminum Header, Side Jambs, and Bottom Sill; Top Hangers for 1/4" (6 mm) or 3/8" (10 mm) glass, Back-to-Back Knob, 24" (610 mm) Towel Bar, Nylon Rollers, Bottom Guide, Screws, and Bumpers. Tempered glass and silicone sealant are supplied by the installer to complete the installation. Since all rollers are overhead, the Bottom Sill and Side Jambs are uncluttered, making cleaning easy. They are available in up to six stock sizes. Extrusions, Bottom Guides, Hardware Packages, and other accessories may be ordered separately (see next page). Custom units are available.

### SPECIFICATIONS:

**Materials:** Extrusions (Aluminum); Towel Bar (Brass Tubing); Knob (Solid Brass)

**For Glass Thickness:** 1/4" (6 mm) or 3/8" (10 mm) (Glass not included in Kit)

**Include:** Aluminum Extrusions, Top Hangers for 3/8" (10 mm) or 1/4" (6 mm), 24" (610 mm) Towel Bar, Knob, Hardware Package, and Installation Instructions

**Glass Fabrication:** Towel Bar – Two 1/2" (12 mm) Diameter Holes, 24" (610 mm) Center-to-Center; Knob – One 1/2" (12 mm) Diameter Hole; Top Hangers – Four 1/2" (12 mm) Diameter Holes (two per glass panel) (see [crlaurence.com](http://crlaurence.com) for complete information).



Custom 90 Degree Unit Shown

Our DK Series Kits Have Metal Jambs for a Traditional Look Without Sacrificing Style

DESIGNED BY C.R. LAURENCE

1/4" (6 MM) GLASS* CAT. NO.	3/8" (10 MM) GLASS* CAT. NO.	SIZE (WIDTH X HEIGHT)
DK146060	DK386060	60" x 60" (1.52 m x 1.52 m)
DK146072	DK386072	60" x 72" (1.52 m x 1.83 m)
—	DK386080	60" x 80" (1.52 m x 2.03 m)
DK147260	DK387260	72" x 60" (1.83 m x 1.52 m)
—	DK387272	72" x 72" (1.83 m x 1.83 m)
—	DK387280	72" x 80" (1.83 m x 2.03 m)

\* Specify Finish When Ordering

AVAILABLE IN FOUR STOCK FINISHES



Brite Anodized   Brite Gold Anodized   Brushed Nickel   Oil Rubbed Bronze

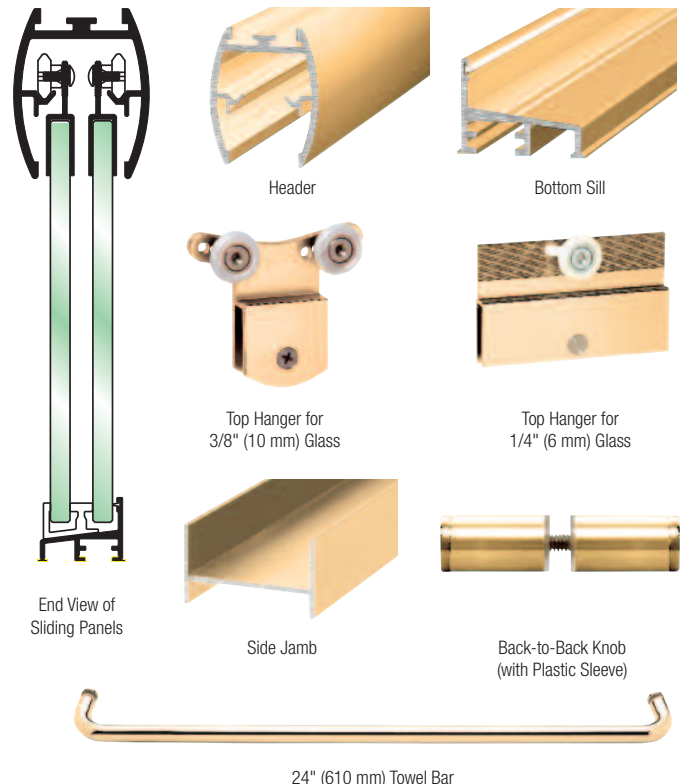
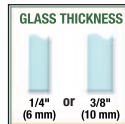

End View of Sliding Panels

Header

Bottom Sill

Top Hanger for 3/8" (10 mm) Glass

Top Hanger for 1/4" (6 mm) Glass

Side Jamb

Back-to-Back Knob (with Plastic Sleeve)

24" (610 mm) Towel Bar

# COTTAGE DK SERIES FRAMELESS SLIDING SHOWER DOOR SYSTEM COMPONENTS

## COTTAGE DK SERIES SYSTEM COMPONENTS

- Individual Supplementary Extrusions and Hardware Components to Convert Our Frameless Shower Door Kits Into Angled Enclosures or Wider Inline Units
- Brite Anodized, Brite Gold Anodized, Brushed Nickel, and Oil Rubbed Bronze Finishes to Match Our Kits
- Do It Yourself, or You Can Send Us a Drawing to Customize a Unit for You

DK Series Cottage Components add versatility to our Frameless Sliding Shower Door Kits, and allow the option of additional panels to create a designer enclosure, or simply construct your own sliding unit by combining the various parts. Stock lengths of Headers, Header Fillers, Bottom Sills, Sidelite Sills, and Side Jambs, along with Top Hangers and other accessory items to complete the selection are included. Glass is not included.

Use these components to build an enclosure to meet your requirements. You also have the option of sending us a drawing of the shower opening email or by fax. We will put together a customized kit with everything you will need (except the glass and the silicone). Contact CRL Frameless Shower Technical Sales for details.

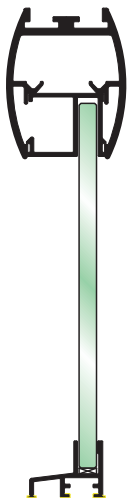
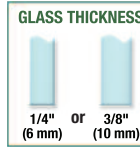

End View of Fixed Panel

### SPECIFICATIONS:

**Materials:** Extrusions (Aluminum), Knob (Solid Brass), Towel Bar (Brass Tubing)

**For Glass Thickness:** 1/4" (6 mm) and 3/8" (10 mm) (Glass not included)

### Recommended Maximum Slider Sizes:

1/4" (6 mm) Glass: 60" W x 72" H

(1.52 x 1.83 m) or 72" W x 60" H

(1.83 x 1.52 m); 3/8" (10 mm) Glass:

72" W x 80" H (1.83 x 2.03 m)

**Glass Fabrication:** See opposite page



Towel Bar

**CAT. NO. BMNW24** = 24" (610 mm)

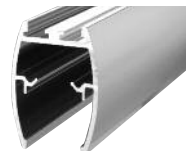

Header

**CAT. NO. DK61**  
= 72" (1.83 m)  
**CAT. NO. DK61144**  
= 144" (3.66 m)

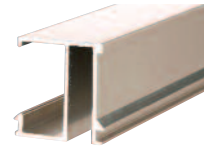

Header Filler

**CAT. NO. DK62**  
= 72" (1.83 m)  
**CAT. NO. DK62144**  
= 144" (3.66 m)



Top Hanger

**CAT. NO. DK66**  
for 3/8" (10 mm) Glass



Bottom Sill

**CAT. NO. DK63**  
= 72" (1.83 m)  
**CAT. NO. DK63144**  
= 144" (3.66 m)

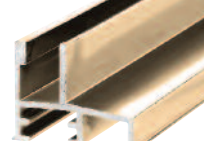

Sidelite Sill

**CAT. NO. DK64**  
= 72" (1.83 m)  
**CAT. NO. DK64144**  
= 144" (3.66 m)



Top Hanger

**CAT. NO. DK67**  
for 1/4" (6 mm) Glass



Bottom Sill Filler Extrusion

**CAT. NO. DK7172**

Make your own bottom filler for out-of-level sills

Custom Made Tapered Bottom Sill Fillers

**CAT. NO. DK71**

Precision-made to order by C.R. Laurence Manufacturing

Side Jamb Filler Extrusion

**CAT. NO. DK7080**

Make your own Side Jamb Filler for out-of-level or custom fabricated side jambs

Custom Made Side Jamb Fillers

**CAT. NO. DK70**

Made to your specifications by C.R. Laurence Manufacturing



Back-to-Back Knob (with Plastic Sleeve)

**CAT. NO. SDKP112**

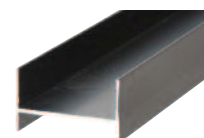

Side Jamb

**CAT. NO. DK65**  
= 80" (2.03 m)  
**CAT. NO. DK65144**  
= 144" (3.66 m)



Bottom Guide

**CAT. NO. DK6914**  
for 1/4" (6 mm) Glass  
**CAT. NO. DK6938**  
for 3/8" (10 mm) Glass

### CATALOG NUMBERS FOR OTHER "DK" SERIES COMPONENTS

COMPONENT DESCRIPTION	BRITE ANODIZED	BRITE GOLD ANODIZED	BRUSHED NICKEL	OIL RUBBED BRONZE
Hardware Package	DK68B	DK68G	DK68B	DK68BL
Back-to-Back Knob	SDKP112CH	SDKP112BR	SDKP112BN	SDKP112ORB
24" Towel Bar	BMNW24CH	BMNW24BR	BMNW24BN	BMNW24ORB

# LAGUNA SERIES SLIDING GLASS DOOR SYSTEM WITH ANTI-LIFT SAFETY FEATURES

## LAGUNA SERIES SLIDING GLASS DOOR SYSTEM WITH ANTI-LIFT SAFETY FEATURES

- New Anti-Lift Features for Added Safety
- All 316 Alloy Brushed Stainless Steel Construction
- Ideal for Interior Applications
- For Use With 3/8" or 1/2" (10 or 12 mm) Tempered Glass
- Comes With All Fasteners Needed for Either Flush (Countersunk) or Surface (Straight Hole) Mounting
- Custom Adaptor Kits Available for Wood Door Applications



TYPICAL WALL MOUNT INSTALLATION



We have upgraded our popular Laguna Series Sliding Glass Door System to now include a new 'anti-lift' feature. Through a combination of additions and very subtle changes, we have improved the performance, safety, and security while still offering a clean, simple look. The Laguna Series Sliding Glass Door System can be installed on glass partitions, or directly to the side of a sufficiently reinforced wall. The adjustable Top Rollers make final adjustments quick and easy, eliminating the need to remove the door. Their smooth operation and solid stainless steel construction minimizes maintenance issues.

CRL provides you with all the glass attachment fasteners for either flush mounting, requiring a countersunk hole, or surface mounting, requiring a straight hole. The glass attachment fasteners accommodate either 3/8" or 1/2" (10 or 12 mm) tempered glass.

**NOTE:** Laminated glass cannot be used with Laguna Kits.

Standardized sets allow you to make planning and purchasing quick and easy for basic installations. We offer four different kits; two for wall mounting, and two for glass mounting. Available accessories give you the opportunity to customize the standard sets to accommodate the most imaginative designers. All components are sized to easily ship via UPS, which helps to keep your job costs and lead times down.

For more information or ordering assistance, contact CRL Technical Sales at (800) 421-6144 in the U.S., (877) 421-6144 from Canada, or (323) 588-1281 International, and ask for Ext. 7740. You can also e-mail us through our web site at [crlaurence.com](http://crlaurence.com). From the home page click on Contact Us, and then click on Technical Sales for Commercial Products.



TYPICAL GLASS MOUNT INSTALLATION

See [crlaurence.com](http://crlaurence.com) or our CRL63A Catalog for a complete array of component parts.

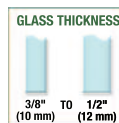

## LAGUNA SERIES WALL MOUNT SINGLE SLIDER KIT

- New Anti-Lift Design
- Assembly Contains All Necessary Hardware to Complete the Installation With 3/8" or 1/2" (10 or 12 mm) Tempered Glass
- Brushed Stainless Steel Construction

CAT. NO. LSWM3BS

The CRL Laguna Series Wall Mount Single Slider Kit contains all the components you will need (except the tempered glass) to complete this style of installation. This model is used in applications where you are attaching a single sliding door to the inside face of a sufficiently reinforced wall.

The Anti-Lift Sliding Door Top Rollers can be attached to the glass with either Surface Mount or Flush Mount Fittings (both are supplied). The Rollers have a 1/8" (3.2 mm) up or down vertical adjustment to aid in door alignment. This system should only be used with 3/8" or 1/2" (10 or 12 mm) tempered glass.

**NOTE:** Laminated glass cannot be used.

### THE FOLLOWING ARE RECOMMENDED LIMITATIONS FOR THIS SYSTEM:

- Minimum Panel Width:** 37-13/16" (960 mm)
- Maximum Panel Width:** 53-9/16" (1360 mm)
- Maximum Panel Height:** 98-7/16" (2500 mm)
- Maximum Panel Weight:** 220 lbs (100 kg)

The panel height should never exceed 2.5 times the width of the panel. Maximum available length of the top track is 104" (2640 mm).

Please contact Technical Sales if any of these limitations cannot be met.

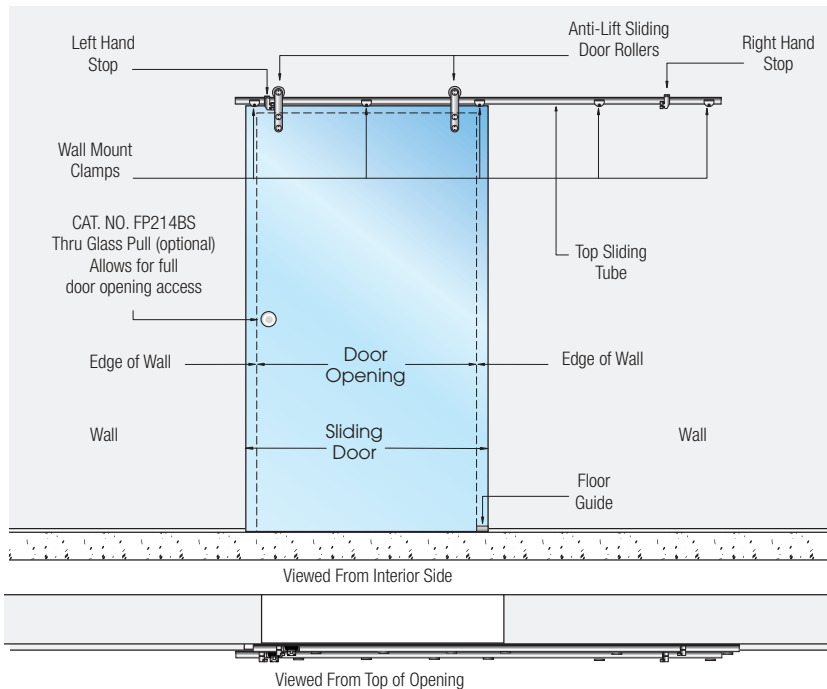

Complete glass fabrication details and drawings are available from [crlaurence.com](http://crlaurence.com) or by contacting our Technical Sales Department at (800) 421-6144 in the U.S., (877) 421-6144 from Canada, or (323) 588-1281 International. Ask for Ext. 7740. You can send e-mail through the [crlaurence.com](http://crlaurence.com) home page. Click on Contact Us, and then click on Technical Sales for Commercial Products.

EACH CAT. NO. LSWM3BS  
KIT CONTAINS:

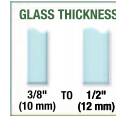

Two CRL Laguna Series  
Anti-Lift Top Rollers  
With Glass Fittings



One CRL Laguna Series Top Sliding Tube  
With End Caps at 104" (2.64 m) in Length



Five CRL Laguna Series Top  
Sliding Tube Wall Mount Clamps



Two CRL Laguna Series Door Stops  
(One Left Hand and One Right Hand)



One CRL Laguna Series  
Bottom Floor Guide

# LAGUNA SERIES WALL MOUNT BI-PARTING SLIDER KIT

## LAGUNA SERIES WALL BI-PARTING SLIDER KIT

- New Anti-Lift Design
- Assembly Contains All Necessary Hardware to Complete the Installation With 3/8" or 1/2" (10 or 12 mm) Tempered Glass
- Brushed Stainless Steel Construction

CAT. NO. LSWM4BS

The CRL Laguna Series Wall Mount Single Slider Kit contains all the components you will need (except the tempered glass) to complete this style of installation. This model is used in applications where you are attaching a single sliding door to the inside face of a sufficiently reinforced wall.

The Anti-Lift Sliding Door Top Rollers can be attached to the glass with either Surface Mount or Flush Mount Fittings (both are supplied). The Rollers have a 1/8" (3.2 mm) up or down vertical adjustment to aid in door alignment. This system should only be used with 3/8" or 1/2" (10 or 12 mm) tempered glass. **NOTE:** Laminated glass cannot be used.

### THE FOLLOWING ARE RECOMMENDED LIMITATIONS FOR THIS SYSTEM:

<b>Minimum Panel Width:</b>	37-13/16" (960 mm)
<b>Maximum Panel Width:</b>	53-9/16" (1360 mm)
<b>Maximum Panel Height:</b>	98-7/16" (2500 mm)
<b>Maximum Panel Weight:</b>	220 lbs (100 kg)

The panel height should never exceed 2.5 times the width of the panel.  
Maximum available length of the top track is 104" (2640 mm).

Please contact Technical Sales if any of these limitations cannot be met.

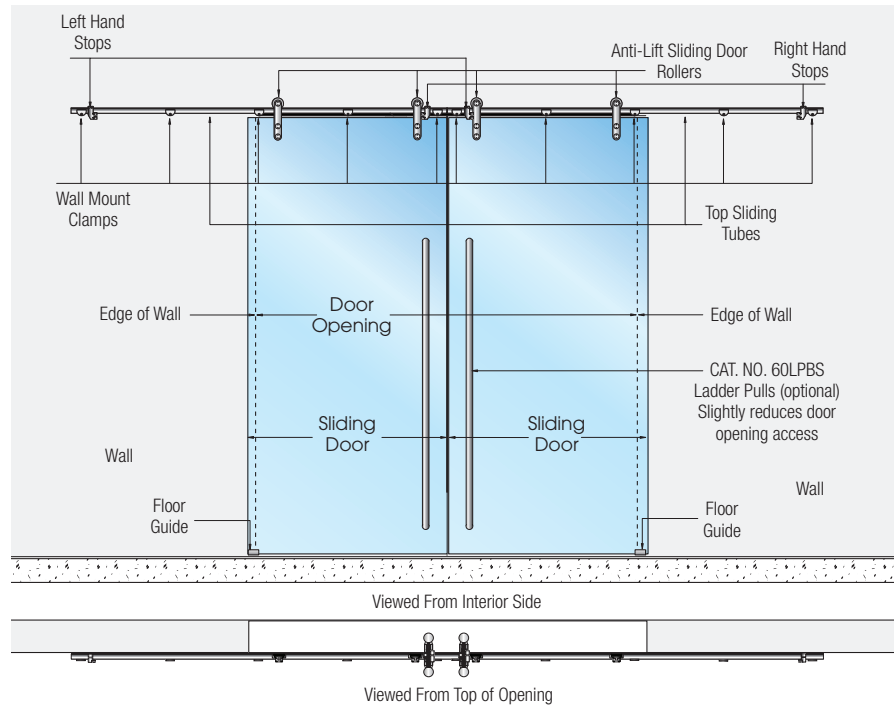

Complete glass fabrication details and drawings are available from [crlaurence.com](http://crlaurence.com) or by contacting our Technical Sales Department at (800) 421-6144 in the U.S., (877) 421-6144 from Canada, or (323) 588-1281 International. Ask for Ext. 7740. You can send e-mail through the [crlaurence.com](http://crlaurence.com) home page. Click on Contact Us, and then click on Technical Sales for Commercial Products.

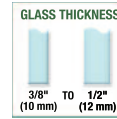

EACH CAT. NO. LSWM4BS  
KIT CONTAINS:



Four CRL Laguna Series  
Anti-Lift Top Rollers  
With Glass Fittings



Two CRL Laguna Series Top Sliding Tubes  
With End Caps at 104" (2.64 m) in Length



Ten CRL Laguna Series Top  
Sliding Tube Wall Mount Clamps



Four CRL Laguna Series Door Stops  
(Two Left Hand and Two Right Hand)



Two CRL Laguna Series  
Bottom Floor Guides

## LAGUNA SERIES GLASS MOUNT SINGLE SLIDER KIT

- New Anti-Lift Design
- Assembly Contains All Necessary Hardware to Complete the Installation With 3/8" or 1/2" (10 or 12 mm) Tempered Glass
- Brushed Stainless Steel Construction

CAT. NO. LSGM3BS

The CRL Laguna Series Glass Mount Single Slider Kit contains all the components you will need (except the tempered glass) to complete this style of installation. This model is used in applications where you are attaching a single sliding door in an 'all-glass' opening where you have a wall on one end next to the door, a glass transom above the door, and a fixed glass panel on the other side of the door. Bi-parting double doors are not possible for this application.

The Anti-Lift Sliding Door Top Rollers can be attached to the glass with either Surface Mount or Flush Mount Fittings (both are supplied). The Rollers have a 1/8" (3.2 mm) up or down vertical adjustment to aid in door alignment. This system should only be used with 3/8" or 1/2" (10 or 12 mm) tempered glass. **NOTE:** Laminated glass cannot be used.

### THE FOLLOWING ARE RECOMMENDED LIMITATIONS FOR THIS SYSTEM:

- Minimum Panel Width:** 37-13/16" (960 mm)
- Maximum Panel Width:** 53-9/16" (1360 mm)
- Maximum Panel Height:** 98-7/16" (2500 mm)
- Maximum Panel Weight:** 220 lbs (100 kg)

The panel height should never exceed 2.5 times the width of the panel.  
Maximum available length of the top track is 104" (2640 mm).

Please contact Technical Sales if any of these limitations cannot be met.

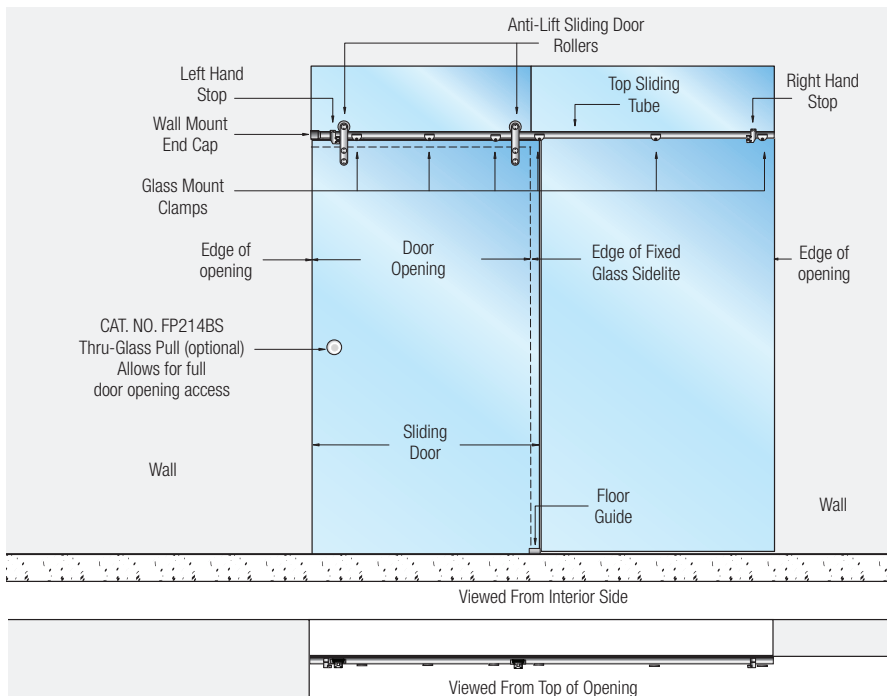

Complete glass fabrication details and drawings are available from [crlaurence.com](http://crlaurence.com) or by contacting our Technical Sales Department at (800) 421-6144 in the U.S., (877) 421-6144 from Canada, or (323) 588-1281 International. Ask for Ext. 7740. You can send e-mail through the [crlaurence.com](http://crlaurence.com) home page. Click on Contact Us, and then click on Technical Sales for Commercial Products.

EACH CAT. NO. LSGM3BS  
KIT CONTAINS:

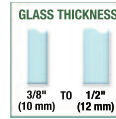

Two CRL Laguna Series  
Anti-Lift Top Rollers  
With Glass Fittings



One CRL Laguna Series Top Sliding Tube  
With End Caps at 104" (2.64 m) in Length



One CRL Laguna Series Top Sliding Tube Wall  
Mount End Cap (fastener to wall is not included)



Six CRL Laguna Series Top Sliding  
Tube Glass Mount Clamps



Two CRL Laguna Series Door Stops  
(One Left Hand and One Right Hand)



One CRL Laguna Series  
Bottom Floor Guide

# SUITE SERIES FRAMELESS SLIDING SHOWER DOOR SYSTEM

## EK SUITE SERIES FOR 1/4" (6 MM) GLASS

- Designed for Use With 1/4" (6 mm) Tempered Glass (Not Included)
- Clamp-On Hanger Bracket Eliminates Glass Drilling
- Offered Only in Inline Units With Metal Side Jamb
- Low Profile 2-9/16" (65 mm) Header is Reversible So You Can Expose Either the Curved or Flat Side
- Brite Anodized, Brite Gold Anodized, Brushed Nickel, and Oil Rubbed Bronze in Two Stock Sizes
- Custom Finish Units Also Available

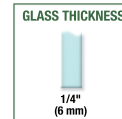

The EK Suite Series Frameless Bypass Sliding Shower Door Kit for 1/4" (6 mm) thick tempered safety glass provides an alternative design and mounting method to our Deluxe Cottage Series Sliders. The Hanger Bracket is a cost-reducing device as it clamps directly onto the glass and eliminates the need for drilling holes (set screws only). The brackets allow for smooth, quiet operation and long service life at a lower cost.

The specially designed Header is only 2-9/16" (65 mm) tall. This reduces the visibility of the top metal, and allows more of the frameless 'all-glass' look. It is reversible so the customer has the choice of using the gently curved side, or the flat side with top and bottom edge bevels.

The EK Suite Series is available exclusively with metal side jamba, does not offer the clear jamb system, and is available only for inline units. Kits with fixed panels are not available.

Two popular stock sizes are available: 60" W x 60" H (1.52 m x 1.52 m) and 60" W x 72" H (1.52 m x 1.83 m). The EK Suite Series comes in four popular finishes. Custom finishes are available upon request. Glass is not included in any kit.

Our Suite Series Kits for Use With 1/4" (6 mm) Glass Have Many of the Fine Features Found in Our Cottage Series Shower Door Kits

DESIGNED BY C.R. LAURENCE

### SPECIFICATIONS:

**Materials:** Extrusions (Aluminum);

Towel Bar (Brass Tubing); Knob (Solid Brass)

**For Glass Thickness:** 1/4" (6 mm) (Glass not included in Kit)

**Include:** Aluminum Extrusions, 24" (610 mm) Towel Bar, Knob, Hardware Package, and Installation Instructions

**Glass Fabrication:** Towel Bar – Two 1/2" (12 mm) Diameter Holes, 24" (610 mm) Center-to Center; Knob – One 1/2" (12 mm) Diameter Hole

**Maximum Recommended Size:** 60" W x 72" H (1.52 m x 1.83 m)

### EK SUITE SERIES SLIDING SHOWER DOOR KITS

CAT. NO.*	SIZE (WIDTH X HEIGHT)
EK146060	60" x 60" (1.52 m x 1.52 m)
EK146072	60" x 72" (1.52 m x 1.83 m)

\* Specify Finish When Ordering

AVAILABLE IN FOUR STOCK FINISHES



Go to [crlaurence.com](http://crlaurence.com) or see our **SD12 Frameless Shower Door Hardware and Supplies Catalog** for more information on all extrusions and replacement parts.

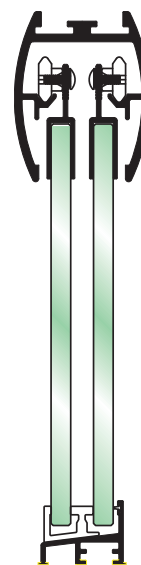

End View of Sliding Panels

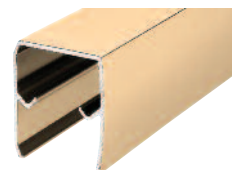

Header

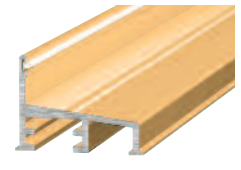

Bottom Sill



'No Drill' Top Hanger

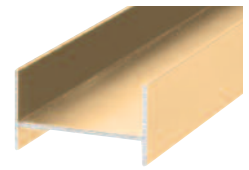

Side Jamb



Bottom Guide



Back-to-Back Knob (with Plastic Sleeve)



24" (610 mm) Towel Bar

# MK SERIES FRAMELESS SLIDING SHOWER DOOR SYSTEM

## MK SERIES FOR 1/4" (6 MM) OR 3/8" (10 MM) GLASS

- Concealed Overhead Roller Design Allows Greater Glass Exposure With Less Exposed Metal
- Bonded Hanger System for Easy Installation
- Bolt-Through Hanger System Available on Special Order
- Custom Units Available

Our MK Series Frameless Bypass Slider Kits provide all the extrusions (Header, Top Hanger Rails, Bottom Track, and Side Jamb) necessary for installation, as well as a Towel Bar, Knob, Rollers, Guide, and Installation Hardware. The glass and silicone sealer are supplied by the installer. The easy-to-clean Bottom Track utilizes a center-mounted guide. Available in custom sizes, configurations, and finishes on special order.

### SPECIFICATIONS:

**Materials:** Extrusions (Aluminum); Side Jamb (Polycarbonate); Towel Bar (Brass Tubing); Knob (Solid Brass)

**For Glass Thickness:** 1/4" (6 mm) or 3/8" (10 mm) (Glass not included in Kit)

**Include:** Aluminum Extrusions, 24" (610 mm) Towel Bar, Knob, Hardware Package, and Installation Instructions

**Glass Fabrication:** Towel Bar – Two 1/2" (12 mm) Diameter Holes, 24" (610 mm) Center-to Center; Knob – One 1/2" (12 mm) Diameter Hole

**Maximum Recommended Size:** 60" W x 72" H (1.52 m x 1.83 m)

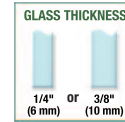

AVAILABLE IN FOUR STOCK FINISHES



### MK SLIDER KITS FOR 1/4" (6 MM) GLASS

CAT. NO.	SIZE (WIDTH X HEIGHT)	FINISH
<b>S146060BA</b>	60" x 60" (1.52 m x 1.52 m)	Brite Anodized
<b>S146060BGA</b>	60" x 60" (1.52 m x 1.52 m)	Brite Gold Anodized
<b>S146060BN</b>	60" x 60" (1.52 m x 1.52 m)	Brushed Nickel
<b>S146060W</b>	60" x 60" (1.52 m x 1.52 m)	White
<b>S146072BA</b>	60" x 72" (1.52 m x 1.83 m)	Brite Anodized
<b>S146072BGA</b>	60" x 72" (1.52 m x 1.83 m)	Brite Gold Anodized
<b>S146072BN</b>	60" x 72" (1.52 m x 1.83 m)	Brushed Nickel
<b>S146072W</b>	60" x 72" (1.52 m x 1.83 m)	White

### MK SLIDER KITS FOR 3/8" (10 MM) GLASS

CAT. NO.	SIZE (WIDTH X HEIGHT)	FINISH
<b>S386060BA</b>	60" x 60" (1.52 m x 1.52 m)	Brite Anodized
<b>S386060BGA</b>	60" x 60" (1.52 m x 1.52 m)	Brite Gold Anodized
<b>S386060BN</b>	60" x 60" (1.52 m x 1.52 m)	Brushed Nickel
<b>S386060W</b>	60" x 60" (1.52 m x 1.52 m)	White
<b>S386072BA</b>	60" x 72" (1.52 m x 1.83 m)	Brite Anodized
<b>S386072BGA</b>	60" x 72" (1.52 m x 1.83 m)	Brite Gold Anodized
<b>S386072BN</b>	60" x 72" (1.52 m x 1.83 m)	Brushed Nickel
<b>S386072W</b>	60" x 72" (1.52 m x 1.83 m)	White

## MK EXTRUSIONS AND ACCESSORIES

- Components Available Separately So You Can Build Your Own Units

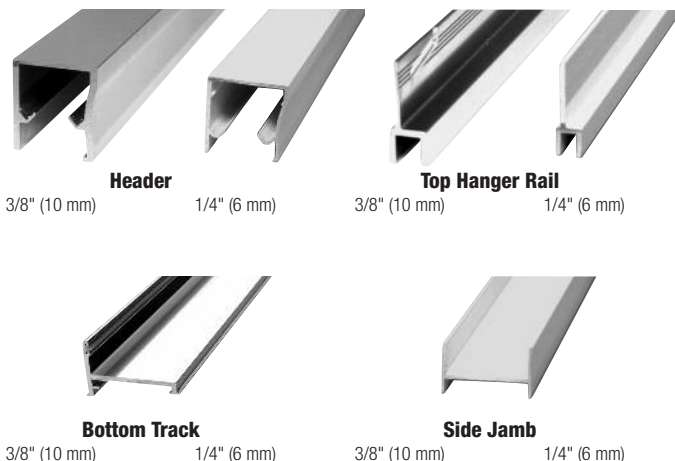

### MK EXTRUSIONS AND ACCESSORIES

3/8" (10 MM) GLASS CAT. NO.	1/4" (6 MM) GLASS CAT. NO.	DESCRIPTION	FINISH
<b>H72BA</b>	<b>H7214BA</b>	72" (1.83 m) Header	Brite Anodized
<b>H72BGA</b>	<b>H7214BGA</b>	72" (1.83 m) Header	Brite Gold Anodized
<b>H72BN</b>	<b>H7214BN</b>	72" (1.83 m) Header	Brushed Nickel
<b>H72W</b>	<b>H7214W</b>	72" (1.83 m) Header	White
<b>TR72BA</b>	<b>TR7214BA</b>	72" (1.83 m) Top Hanger Rail	Brite Anodized
<b>TR72BGA</b>	<b>TR7214BGA</b>	72" (1.83 m) Top Hanger Rail	Brite Gold Anodized
<b>TR72BN</b>	<b>TR7214BN</b>	72" (1.83 m) Top Hanger Rail	Brushed Nickel
<b>TR72W</b>	<b>TR7214W</b>	72" (1.83 m) Top Hanger Rail	White
<b>BT72BA ▲</b>	<b>BT72BA ▲</b>	72" (1.83 m) Bottom Track	Brite Anodized
<b>BT72BGA ▲</b>	<b>BT72BGA ▲</b>	72" (1.83 m) Bottom Track	Brite Gold Anodized
<b>BT72BN ▲</b>	<b>BT72BN ▲</b>	72" (1.83 m) Bottom Track	Brushed Nickel
<b>BT72W ▲</b>	<b>BT72W ▲</b>	72" (1.83 m) Bottom Track	White
<b>SJ72BA</b>	<b>SJ72BA</b>	72" (1.83 m) Side Jamb	Brite Anodized
<b>SJ72BGA ▲</b>	<b>SJ72BGA ▲</b>	72" (1.83 m) Side Jamb	Brite Gold Anodized
<b>SJ72BN ▲</b>	<b>SJ72BN ▲</b>	72" (1.83 m) Side Jamb	Brushed Nickel
<b>SJ72W ▲</b>	<b>SJ72W ▲</b>	72" (1.83 m) Side Jamb	White
<b>HP38BA</b>	<b>HP14BA</b>	Hardware Package Only *	Brite Anodized
<b>HP38BGA</b>	<b>HP14BGA</b>	Hardware Package Only *	Brite Gold Anodized
<b>HP38BN</b>	<b>HP14BN</b>	Hardware Package Only *	Brushed Nickel
<b>HP38W</b>	<b>HP14W</b>	Hardware Package Only *	White

▲ The same Bottom Track and Side Jamb may be used for either 1/4" (6 mm) or 3/8" (10 mm) glass.

\* Hardware Package does not include Towel Bar or Knob.

# POPULAR HANDLES, KNOBS, AND TOWEL BARS

## POPULAR HANDLES, KNOBS, AND TOWEL BARS



**CAT. NO. BM6X6**  
6" (152 mm) Size

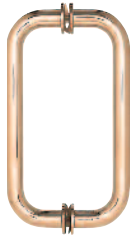

**CAT. NO. BM8X8**  
8" (203 mm) Size

### BM SERIES BACK-TO-BACK TUBULAR PULL HANDLES WITH METAL WASHERS

The BM Series of Back-to-Back Tubular Pull Handles With Metal Washers are constructed of 1.5 mil thick heavy brass tubing. Decorative metal back-up washers are included, as well as plastic washers to protect against glass-to-metal contact. Consists of one pull for each side of the door (back-to-back), and come in 6" and 8" (152 mm and 203 mm) sizes.

#### SPECIFICATIONS:

**Glass Thickness Range:** 1/4" (6 mm) to 1/2" (12 mm)  
**Material:** 3/4" (19 mm) Diameter Brass Tubing (1.5 mil thick)  
**Hole Diameter Required:** 1/2" (12 mm)  
**Center-to Center Hole Spacing:** 6" (152 mm); 8" (203 mm)



**CAT. NO. SQ6X6**  
6" (152 mm) Size



**CAT. NO. SQ8X8**  
8" (203 mm) Size

### SQ SERIES SQUARE TUBING MITERED CORNER BACK-TO-BACK PULL HANDLES

The sharp looking SQ Series Square Corner Handle gives the clean and traditional look that many designers prefer. This Handle perfectly complements numerous CRL Hinge Series with similar corner styles, such as Geneva, Vienna, Concord, Cardiff, and others, and is a great addition to many sliding systems. Back-up washers and nylon spacers are included to protect against glass-to-metal contact.

#### SPECIFICATIONS:

**Glass Thickness Range:** 1/4" (6 mm) to 1/2" (12 mm)  
**Material:** 3/4" (19 mm) Brass Tubing  
**Hole Diameter Required:** 1/2" (12 mm)  
**Center-to Center Hole Spacing:** 6" (152 mm); 8" (203 mm)

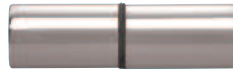

**CAT. NO. SDK112** (Without Plastic Sleeve)    **CAT. NO. SDKP112** (With Plastic Sleeve)

#### Back-to-Back Knob



**CAT. NO. SDK212** (Without Plastic Sleeve)    **CAT. NO. SDKP212** (With Plastic Sleeve)

#### Single-Sided Knob

### CYLINDER STYLE KNOBS

The sleek, cylindrical shape is functional without detracting from the beauty of an 'all glass' door. The Plastic Sleeve Model is ideal for use on sliding bypass shower doors to protect the knob surface. Knob diameter is 3/4" (19 mm), and it stands 1-1/4" (31.8 mm) from the glass surface. The end cap for the Single-Sided Model stands only 5/32" (4 mm) from the glass surface.

#### SPECIFICATIONS:

**Glass Thickness Range:** 1/4" (6 mm) to 1/2" (12 mm)  
**Material:** Solid Brass  
**Hole Diameter Required:** 3/8" (10 mm) or 1/2" (12 mm)

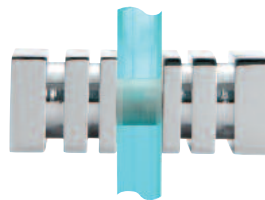

**CAT. NO. SDK160**  
Back-to-Back Knob

### SQUARE STYLE KNOB

The solid brass Square Style Knob will be a favorite of architects, designers, and homeowners who wish to match the square cornered construction of such popular CRL Hinges as the Geneva, Vienna, Concord, Cardiff, and Junior Geneva Series, and is a great addition to many sliding systems. The ribbed appearance will add to the appeal and create a beautifully aesthetic appearance. The Square Style Knob measures 1-3/16" (30 mm) across and stands 1-3/16" (30 mm) from the surface of the glass.

#### SPECIFICATIONS:

**Glass Thickness Range:** 1/4" (6 mm) to 1/2" (12 mm)  
**Material:** Solid Brass  
**Hole Diameter Required:** 1/2" (12 mm)

### IDEAL FOR BYPASS DOORS



**CAT. NO. BMNW24**  
24" (610 mm) Towel Bar  
(Available in Other Sizes)

### BM SERIES SINGLE-SIDED TOWEL BAR WITHOUT METAL WASHERS

The BM Series of Single-Sided Towel Bars Without Metal Washers are designed for glass mounting on fixed panels or doors. The 1/8" low profile end caps make this an ideal bar for sliding bypass doors as well. The bars are constructed of 1.5 mil thick heavy brass tubing. Plastic washers protect against glass-to-metal contact.

#### SPECIFICATIONS:

**Glass Thickness Range:** 1/4" (6 mm) to 1/2" (12 mm)  
**Material:** 3/4" (19 mm) Diameter Brass Tubing  
**Hole Diameter Required:** 1/2" (12 mm)

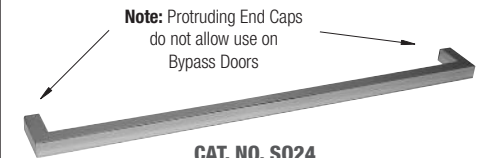

**Note:** Protruding End Caps do not allow use on Bypass Doors

**CAT. NO. SQ24**  
24" (610 mm) Towel Bar  
(Available in Other Series)

### SQ SERIES SQUARE TUBING MITERED CORNER SINGLE-SIDED TOWEL BAR

These sharp looking SQ Series Square Corner Single-Sided Towel Bars offer the clean and modern style that many designers prefer. They perfectly complement numerous CRL Hinges Series with similar corner styles, such as Geneva, Vienna, Concord, Cardiff, and others, and are a great addition to many sliding systems.

#### SPECIFICATIONS:

**Glass Thickness Range:** 1/4" (6 mm) to 1/2" (12 mm)  
**Material:** 3/4" (19 mm) Brass Tubing  
**Hole Diameter Required:** 1/2" (12 mm)

**Note:** Please be sure to check each Sliding Door Kit you purchase to see what accessory items are included. If you need a Handle, Knob, or Towel Bar to complete your installation, see just some of our popular choices here. For a full selection, visit us at [crlaurence.com](http://crlaurence.com), or see our SD12 Frameless Shower Door Hardware and Supplies Catalog. **Caution - Not all items allow sliding doors to bypass. Call for details.**

See [crlaurence.com](http://crlaurence.com) for full selection of Handles, Knobs, and Towel Bars.

# POPULAR INSTALLATION TOOLS

Elegant, beautifully designed frameless shower enclosures cannot become a reality without professional installers using state of the art tools and techniques. Many of the most successful tools have been designed by installers themselves to make their work more foolproof and efficient. In this catalog you will see some of these imaginative ideas brought to fruition and shared with the trade by C.R. Laurence.

Other tools are commonly integrated from one craft into another. Here we will show some of these multi-craft tools of which you may or may not be familiar. You will immediately understand the many ways these tools can make your job easier, more efficient, and more professional.

## CRL SUPER SHIM SHOWER DOOR LEVELER

- Easily Adjustable Micro Leveling
- Eliminates Stacks of Wood or Plastic Shims
- Works With 3/8" to 1/2" (10 to 12 mm) Thick Tempered Glass Doors

The CRL Super Shim Shower Door Leveler is a remarkably simple device that every shower door installer will want in their tool box. The Super Shim is a micro adjustment device which will lift and level any shower door, ensuring a precise alignment every time.

Use from the inside of the shower to adjust the door with hinges applied but not tightened. Adjust vertical and horizontal sightlines then tighten everything down for a perfect installation. SS2LW Wrench included. Minimum order is one pair.



CAT. NO. SS2L



**NEW!**



**GLAZIER INVENTION**



MANUFACTURED IN THE USA  
**BY C.R. LAURENCE**  
An ISO9001:2008 Certified Company

## CRL FRAMELESS BLOCKS

- Use With 3/8" and 1/2" (10 and 12 mm) Thick Tempered Glass to Assist in Aligning and Leveling
- Can be Used to Stage Glass in a Room With All Tile/Stone Floors Prior to Installation
- Safely Set Your Door on the Threshold With a Positive Hold on the Bottom of the Glass
- Adjust the Door Height by Using Setting Blocks Inside the Bottom of the U-Shaped Frameless Block



CAT. NO.	FOR USE WITH
<b>FB38G</b>	3/8" (10 mm) Glass
<b>FB12G</b>	1/2" (12 mm) Glass

Minimum order: 1 set.

**NEW!**



**GLAZIER INVENTION**



## CRL PLUMB/LEVEL FINDER GAUGES

- Use With Your Level to Determine "Out-of-Plumb"
- Five Individual Thickness Gauges

This handy set of CRL Plumb/Level Finder Gauges makes it simple to determine the amount or distance a wall or floor is "out-of-plumb" when using your bubble vial level. Set includes: 1/16", 1/8", 3/16", 1/4" and 3/8" (1.6, 3.2, 4.8, 6.4 and 9.5 mm) thick neoprene gauges. Simply hold the level tight against a horizontal or vertical surface. True the level and use the thickness gauges to determine the amount out of level or plumb the surface is at that point. You can combine gauges when necessary for gaps exceeding 3/8" (9.5 mm). Minimum order is one each.



CAT. NO. PLF1



See Our **ST14 Frameless Shower Door Professional Installation Tool Catalog** for more Imaginative Ideas.



CAT. NO. ST14

MANUFACTURED IN THE USA  
**BY C.R. LAURENCE**  
An ISO9001:2008 Certified Company

# ADJUSTABLE CURVED AND STRAIGHT SHOWER RODS

## ADJUSTABLE CURVED SHOWER RODS

- Adjustable 54" to 72" (1.37 to 1.83 m) Length to Accommodate Most Any Shower Enclosure
- Curved Rod Provides More Shower Space
- Choice of Stainless Steel or Zinc Construction in an Assortment of Popular Finish Options
- Mounting Hardware Included
- Custom Finishes Available



Our NEW Curved Shower Adjustable Rods will provide more space for the shower enclosure. The crescent shaped Rods are adjustable from 54" to 72" (1.37 to 1.83 m), therefore accommodating most any typical shower enclosure. The 1" (25.4 mm) diameter Curved Adjustable Shower Rods come in a choice of durable stainless steel construction (polished and brushed), or economical zinc construction in five popular finishes (polished chrome, polished brass, brushed nickel, oil rubbed bronze, and satin chrome). Mounting hardware is included in each box to assist with easy installation. Custom finishes are available upon demand.



Easily Adjusts From 54" to 72" (1.37 to 1.83 m)

### SPECIFICATIONS:

**Material:** 1" (25.4 mm) Stainless Steel or Zinc Tubing  
**Bar Length:** Adjustable from 54" to 72" (1.37 to 1.83 m)  
**No Glass Fabrication Required**  
**Includes:** Mounting Hardware

CAT. NO.	FINISH	MATERIAL
ASR1PS	Polished Stainless	Stainless Steel
ASR1BS	Brushed Stainless	Stainless Steel
ASR1CH	Polished Chrome	Zinc
ASR1SC	Satin Chrome (matte)	Zinc
ASR1BR	Polished Brass	Zinc
ASR1BN	Brushed Nickel	Zinc
ASR1ORB	Oil Rubbed Bronze	Zinc

### AVAILABLE IN SEVEN FINISHES



## THRU-GLASS TO WALL STRAIGHT SHOWER ROD

- Ideal for Use as a Shower Curtain Rod
- 72" Length Stocked in Polished and Brushed Stainless Steel
- Custom Length and Painted Finishes Available

### AVAILABLE IN TWO STOCK FINISHES

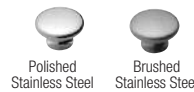

You will find our 72" (1.83 m) long Thru-Glass to Wall Rod a handy item with many uses. A typical use is as a thru-glass curtain rod to be fastened to a return panel. The 3/4" (19 mm) diameter tubing is prepped on one end with a 3/4" (19 mm) diameter end cap. A 1/2" (12 mm) diameter hole is required in the glass. Requires additional fitting for wall attachment (either S3 or S12) Support Bar Fitting.

### SPECIFICATIONS:

**Material:** 3/4" (19 mm) Diameter Stainless Tubing  
**Bar Length:** 72" (1.83 m)  
**Glass Thickness Range:** 1/4" to 1/2" (6 to 12 mm)  
**Glass Fabrication Required:** 1/2" (12 mm) Diameter Hole  
**Includes:** 3/4" (19 mm) Diameter End Cap on One End

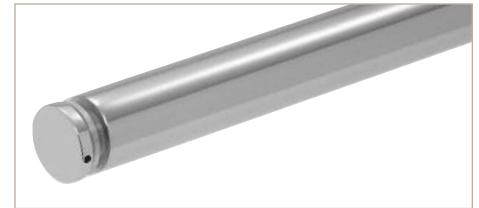

CAT. NO.	FINISH
TUBE3472PS	Polished Stainless
TUBE3472BS	Brushed Stainless

# MORE FRAMELESS HARDWARE, SHOWERS ONLINE, CRL ACQUIRES U.S. ALUMINUM



**CAT. NO. SD12**  
Frameless Shower Door Catalog

- Beautiful Architectural Finishes
- Unequaled Selection of Styles
- Dozens of Finished Installation Photos to Show Your Customers
- New and Innovative Solutions for Installers



**CAT. NO. SDT21**  
Frameless Shower Door Guide  
With Installation Instructions and  
Cut-Out Templates



**CAT. NO. FF4SD**  
Shower Door Flyers for  
Your Retail Sales Counter



See [crlaurence.com](http://crlaurence.com) for our full selection of hardware

## CRL SHOWERS ONLINE WEB-BASED DESIGN, GLASS SIZING, QUOTE, AND ORDERING PROGRAM

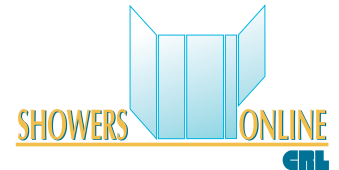

- Revolutionary Program Generates "Go" Glass Sizes From Your Field Measurements
- Web-Based So You Have 24 Hour / 7 Day A Week Access
- Sizes for Shower Enclosures Can be Completed in Just a Few Minutes
- Upon Completion of Data Entry, Simply Push the "Print" Icon to Generate Complete Glass Sizes and Their Templates
- You Have the Ability to Change the Default Deductions for Glass Sizing
- Continued Upgrades to Program Occur at No Extra Expense
- Works on iPads.



**Free 30 Day  
Trial Offer  
Upon Completion  
of Introductory Webinar**  
(Visit [crlaurence.com](http://crlaurence.com) and  
Click on News and Events,  
then Webinars)

### Available in Imperial and Metric Versions

#### BENEFITS OF USING CRL'S SHOWERS ONLINE

- Online Access Means Availability of the Program Anytime, Anywhere... From the Office, Shop or Field
- Sophisticated CAD Processing Takes Place on Our Web Servers, Almost Any Model of PC Can Be Used for Access, Just Web Access is Required
- Accurately Calculates Correct Glass Sizes, and All Hardware Locations, Cut-Outs and Gaps
- Issues Warnings About Possible Problems With the Shower Design
- Builds a Library of Your Most Common Showers Which You Can Used to Start a New Job by Copying From the Most Similar Design in the Library



### In Case You Have Not Heard

In July of 2011 C.R. Laurence Co., Inc. proudly announced the acquisition of U.S. Aluminum Company, formerly a part of the International Aluminum Group. U.S. Aluminum is one of the most respected names in the storefront and curtain wall business. Integration into CRL's powerful Architectural Hardware Program has been a priority to help maximize the U.S. Aluminum offering in terms of products and services.

#### THE STOREFRONT STORE FROM U.S. ALUMINUM

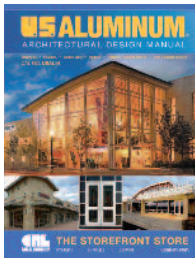

**CAT. NO. USAL14**

- Doors, Entrances, and Storefronts
- Window Walls and Window Systems
- Hurricane Resistant Systems
- Blast Mitigation Systems
- 'All-Glass' Entrance Systems, Stacking Partition System, and Glass Sliders
- Interior Office Front Systems



#### THE CURTAIN WALL CATALOG FROM U.S. ALUMINUM



**CAT. NO. USAL15**

- Doors, Entrances, and Curtain Walls
- Sun Control Systems
- Window Systems
- Blast Mitigation Systems
- 'All-Glass' Entrance Systems, Stacking Partition System, and Glass Sliders
- Interior Office Front Systems
- Guarda™ Security Screen Systems

Product line flyers, spec data sheets, installation diagrams, and other helpful literature are available for all U.S. Aluminum architectural systems. Much of it can be viewed and downloaded from the [usalum.com](http://usalum.com) web site, and we also make it available by mail. Call U.S. Aluminum toll free (800) 262-5151 from anywhere in the United States or Canada to request these materials at any time.



### CRL MASTER AND SPECIALTY CATALOGS

- 03 SEALANTS, ADHESIVES, AND FASTENERS
- 23 FRAMELESS SHOWER DOOR HARDWARE
- 43 AUTO GLASS TOOLS AND WINDOWS
- 53R GLASS AND GLAZING HARDWARE
- 63A ARCHITECTURAL HARDWARE
- 63R ARCHITECTURAL RAILING
- 73 TOOLS, MACHINERY, AND EQUIPMENT
- 83 WINDOW AND DOOR REPLACEMENT HARDWARE



**SD12**  
FRAMELESS SHOWER DOOR HARDWARE AND SUPPLIES



**CRL14D**  
DOORS



**AH11**  
ARCHITECTURAL HARDWARE



**HR11**  
ARCHITECTURAL RAILING SYSTEMS

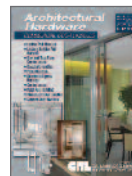

**LP11**  
COMMERCIAL DOOR HANDLES



**AM09**  
ARCHITECTURAL METALS



**HS12**  
HOSPITALITY AND SERVICE HARDWARE



**DC07**  
COMMERCIAL DOOR CONTROLS



**ST14**  
FRAMELESS SHOWER DOOR PROFESSIONAL INSTALLATION TOOLS



**SC12**  
STANDOFF AND CLAMP HARDWARE



**HW2010**  
TUBULAR ARCHITECTURAL HARDWARE



**B2010**  
TEMPERED GLASS DOORS, PANIC, DEADBOLT AND DUMMY HANDLES



**M2010**  
RAILINGS, SMOKE BAFFLES, GLASS GATES



**D2010**  
DISPLAY CASE DOOR SERIES 1301



**GB10**  
GLASS BONDING SYSTEM



**SC14**  
SUN CONTROL SYSTEMS



**TH10**  
TRANSACTION AND SECURITY HARDWARE

## Welcome to the C.R. Laurence Global Web Site



### ONLINE FEATURES INCLUDE:

- Access to All CRL Products Through CRL's Easy-to-Use A to Z Product Index
- Fast and Secure Sign On Process
- Ask Technical and Product Questions Online
- Find Products and Pricing Online Instantly
- View All Current Catalogs Online
- Technical Articles and Product Support
- Ordering and Shipping Information
- Beautiful Installation Photos With CRL Products
- CRL Locations With Addresses, Directions, Phone and Fax Numbers
- Direct E-Mail Connections to CRL Departments
- Account Policies and Credit Terms
- A Calendar of Industry Trade Shows

## C.R. LAURENCE COMPANY

**C.R. Laurence Co., Inc.**  
Corporate Headquarters  
CRL UNITED STATES | [crlaurence.com](http://crlaurence.com)  
2503 E. Vernon Ave., Los Angeles, California 90058-1897  
Toll Free Phone: (800) 421-6144 • Toll Free Fax: (800) 262-3299  
International Phone: (323) 588-1281 • International Fax: (323) 581-6522

**C.R. Laurence of Canada**  
Canadian Headquarters  
CRL CANADA | [crlaurence.ca](http://crlaurence.ca)  
65 Tigi Court, Concord, Ontario L4K 5E4  
Toll Free Phone: (800) 421-6144 • Toll Free Fax: (800) 262-3299  
International Phone: (905) 303-7966 • International Fax: (905) 303-7965

**C.R. Laurence Australia Pty Ltd**  
Australian Headquarters  
CRL Australia | [crlaurence.com.au](http://crlaurence.com.au)  
9 Shale Place, Eastern Creek, NSW 2766  
Toll Free Phone: 1800 424 275 • Toll Free Fax: 1800 813 013  
International Phone: +61 (2) 9851-3444 • International Fax: +61 (2) 9851-3445

**C.R. Laurence of Europe Ltd.**  
European Headquarters  
CRL UK | [crlaurence.co.uk](http://crlaurence.co.uk)  
Charles Babbage Ave., Kingsway Business Park, Rochdale, OL16 4NW England  
FreePhone: 00 800 0421 6144 • Freefax: 00 800 0262 3299  
International Phone: +44 (0) 1706 863 600 • International Fax: +44 (0) 1706 869 860

**C.R. Laurence of Europe GMBH**  
Stuttgart Area, GERMANY  
CRL GMBH | [crlaurence.de](http://crlaurence.de) | [crlaurence.eu](http://crlaurence.eu)  
Boschstrasse 7, D-74360, Ilsfeld, Germany  
FreePhone: 00 800 0421 6144 • Freefax: 00 800 0262 3299  
International Phone: +49 (0)7062 915 93 15 • International Fax: +49 (0)7062 915 93 16